

Article number: 604145036055

Description: Timing belt pulley with hub
HTD 36 14M 55

Measures

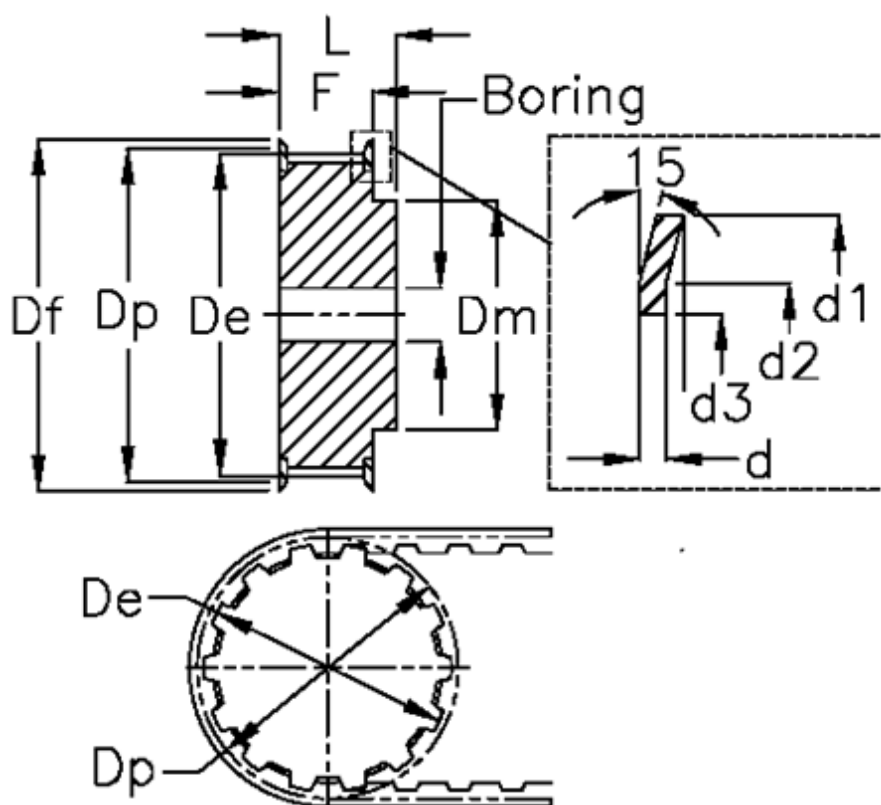

Bore = 24	Dp	= 160.43
d = 2.5	F	= 70
d1 = 168	Flange type	= F52
d2 = 161	L	= 85
d3 = 148	Tooth number	= 36
De = 157.68	Type	= 14M
Df = 168	Weight	= 9.6
Dm = 100	Width	= 55